

Triga

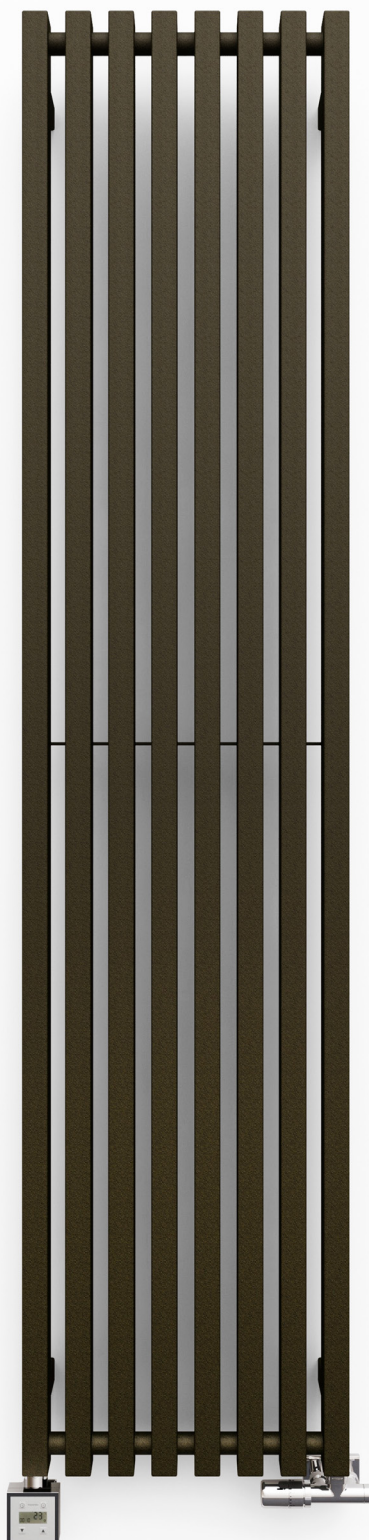

colour included
in the price

TERMA
SINCE 1990



Triga 1900↓ × 380↔ SX
colour: Van Gogh

Integrated thermostatic valve, angled, right, chrome
SLIM thermostatic head, chrome
KTX 3 heating element, chrome



TERMA
SINCE 1990





colour included
in the price

Design: *Terma*

Standard connection:

A \updownarrow 560÷1900:

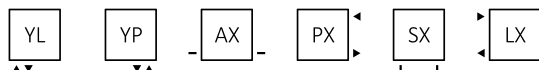

A \updownarrow 560÷610:

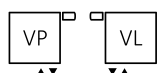

A \updownarrow 900÷1900:

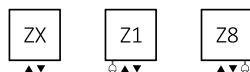

Optional connection:

A \updownarrow 560÷1900:

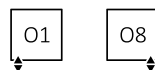

A \updownarrow 560÷610:

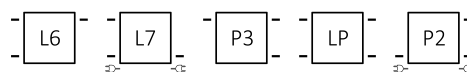
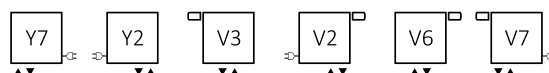

A \updownarrow 900÷1900:

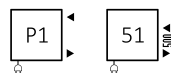
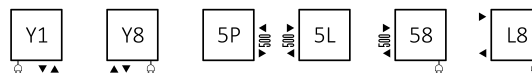



colour included
in the price

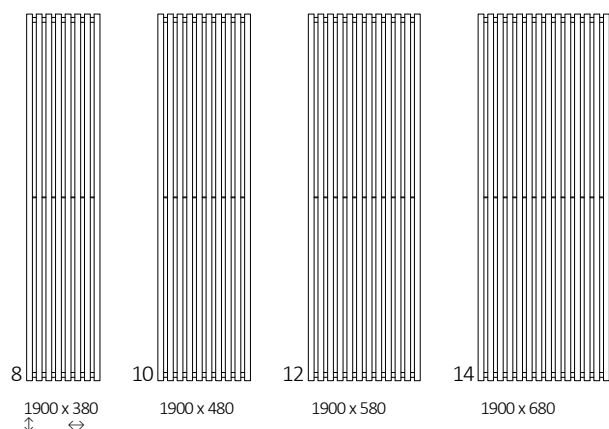
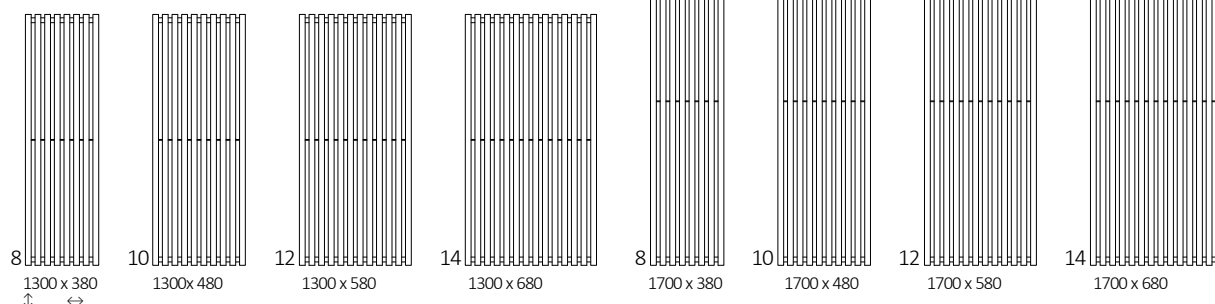
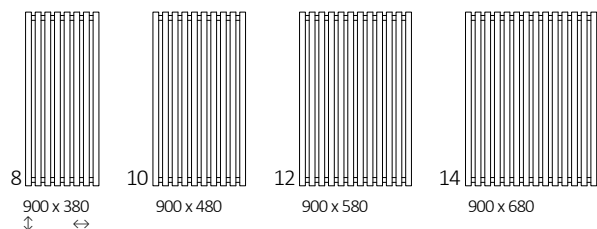
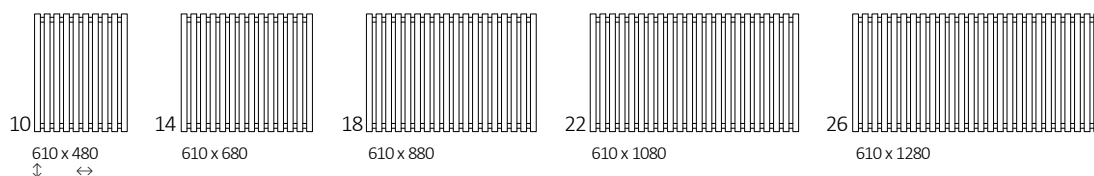
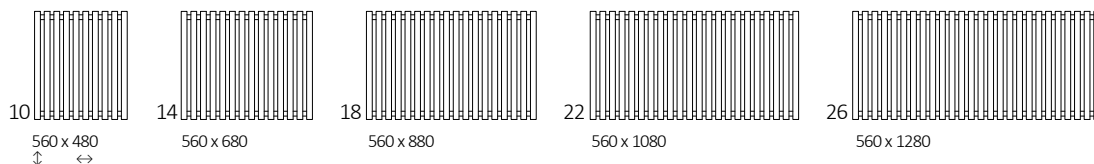

Available sizes:





Specification:

Working pressure: 800 kPa Maximum operating temperature: 95°C

A ↓ [mm]	B ↔ [mm]	C1 [mm]	75/65/20°C [W]	55/45/20°C [W]	 [W]	D [mm]	E [mm]	F [mm]	H [dm³]	 [kg]	Product code <small>Configuration code p. 8</small>
560	480	50	356	192	400	450	380	90	5,72	10,14	WGTRG056048
560	680	50	504	272	600	650	380	90	8,01	14,25	WGTRG056068
560	880	50	652	352	600	850	380	90	10,31	18,36	WGTRG056088
560	1080	50	800	431	800	1050	380	90	12,60	22,47	WGTRG056108
560	1280	50	948	511	1000	1250	380	90	14,90	26,58	WGTRG056128
610	480	50	391	210	400	450	430	90	6,22	10,93	WGTRG061048
610	680	50	554	298	600	650	430	90	8,71	15,36	WGTRG061068
610	880	50	717	385	800	850	430	90	11,21	19,79	WGTRG061088
610	1080	50	880	473	800	1050	430	90	13,70	24,22	WGTRG061108
610	1280	50	1043	560	1000	1250	430	90	16,19	28,65	WGTRG061128
900	380	50	459	242	400	350	720	90	7,29	12,40	WGTRG090038
900	480	50	580	306	600	450	720	90	9,11	15,54	WGTRG090048
900	580	50	701	370	800	550	720	90	10,94	18,67	WGTRG090058
900	680	50	821	433	800	650	720	90	12,76	21,81	WGTRG090068
1300	380	50	652	339	600	350	1120	90	10,48	17,48	WGTRG130038
1300	480	50	824	429	800	450	1120	90	13,10	21,89	WGTRG130048
1300	580	50	996	518	1000	550	1120	90	15,72	26,30	WGTRG130058
1300	680	50	1168	608	1200	650	1120	90	18,34	30,70	WGTRG130068
1700	380	50	850	437	800	350	1520	90	13,67	22,57	WGTRG170038
1700	480	50	1074	552	1000	450	1520	90	17,09	28,24	WGTRG170048
1700	580	50	1298	667	1200	550	1520	90	20,51	33,92	WGTRG170058
1700	680	50	1521	781	1500	650	1520	90	23,93	39,60	WGTRG170068
1900	380	50	961	492	1000	350	1720	90	15,26	25,11	WGTRG190038
1900	480	50	1202	615	1200	450	1720	90	19,08	31,42	WGTRG190048
1900	580	50	1442	737	1500	550	1720	90	22,90	37,73	WGTRG190058
1900	680	50	1682	860	1500	650	1720	90	26,72	44,04	WGTRG190068



colour included
in the price

Technical drawing:

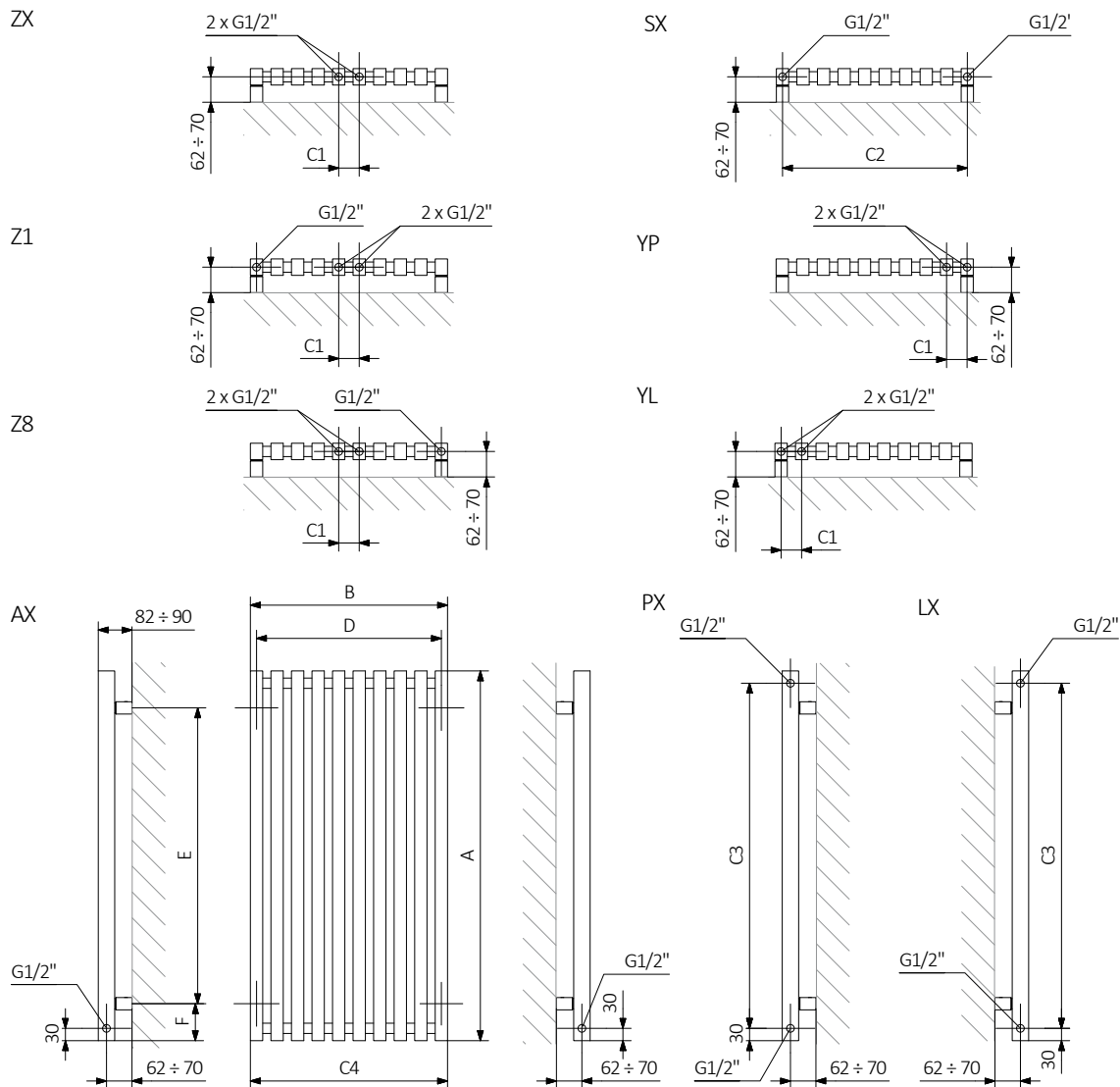

A – Height B – Width C1-C5 – Distance between pipe centres D – Horizontal distance between mounting bracket centres
E – Vertical distance between mounting brackets F – Distance between a mounting bracket and the bottom of the radiator

Collector:

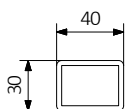

Pipe:

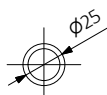



Technical drawing:

VP

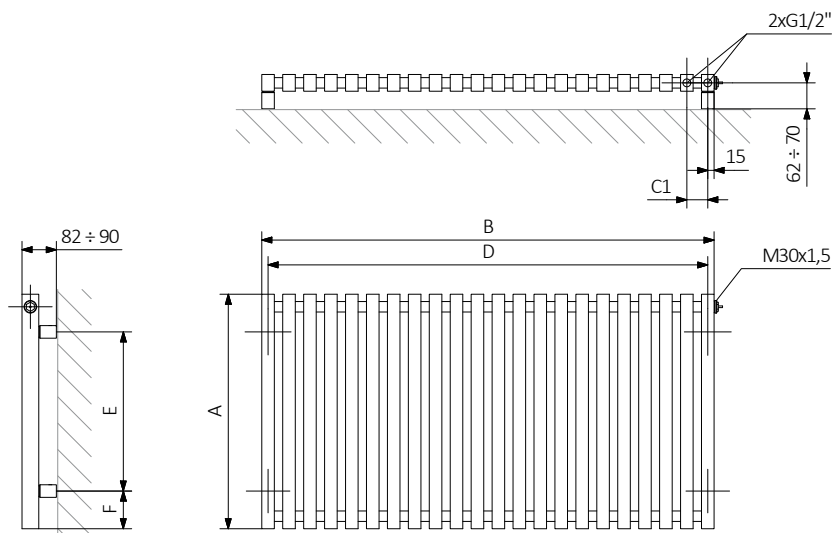

VL

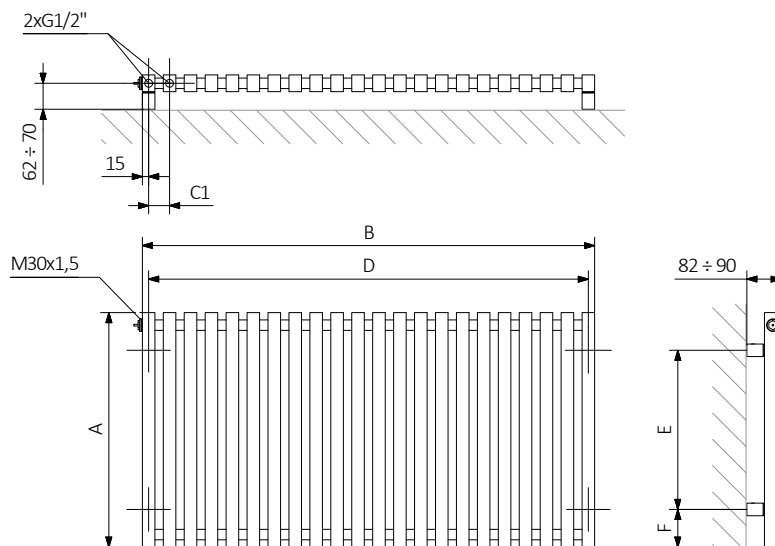

A – Height B – Width C1-C5 – Distance between pipe centres D – Horizontal distance between mounting bracket centres
E – Vertical distance between mounting brackets F – Distance between a mounting bracket and the bottom of the radiator

Collector:

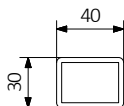

Pipe:

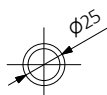



In the table with technical data, the last column lists product codes. When placing an order, please remember to quote the product code followed by the configuration code as shown in the diagram below:

The construction of a water and dual fuel radiator product and configuration code:

WGTRG056048

PRODUCT CODE
(located in the table for the product)

K916SX

CONFIGURATION CODE
(supplemented by hand)

Example Configuration

K 916 SX

Package code
K - carton box

Colour code

Connection code

Epoxy primer

E - Code of epoxy primer is an extra processes.

WGTRG056048 K916SX **E** — *Extra processes or additions code*

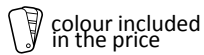

Legend



Radiator available in a "water" version.



Radiator suitable for dual fuel connection. Electric heating element can be installed.



Radiator available in electric only version. It comes prefilled with a 'heating medium' and equipped with a heating element. All tested and ready to use.



Connection types dedicated for this radiator. The icon shows the flow and return connections for the radiator as well as the thermostatic valve and heating element position if applicable.



Suggested heating element power output for electric and dual fuel versions.



Weight.



Capacity.



Available in chrome finish.



No additional payment for a color.