

3.5 KDDQ44X60 — Fresh Air Intake Kit (Direct Installation Type)





Remarks:

1. This kit can be installed to the Ceiling mounted cassette type (Multi-flow).
2. When installing this kit, duct (Nominal dia. : $\phi 100$) is required on site.

- In case that metal duct is penetrated through wooden walls, make sure the duct and the wall electrically insulated.
- Install the duct inclined downwardly to outdoor so that the rain may not get into the duct. (Inclination 1/100 to 1/50)
- To avoid birds, small animals or insects getting inside the duct, make sure to install net where it contacts the outside air.

Contents

Prior to installation, make sure you have the complete kit of parts.

Name	① Duct flange	② Screws	③ Insulation for duct flange	④ Insulation for opening of unit	⑤ Installation manual
Q'ty	1 piece	4 pieces	1 piece	1 piece	1 piece
Shape		 M4x12			

Necessary tools

Philips head screw driver, nipper, cutter etc.

① Installation procedures of duct flange

1. Cut off the knockout hole on the side plate. (Fig.1)

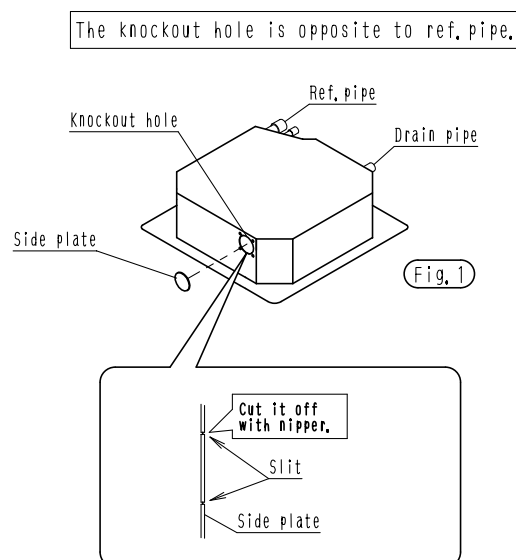

2P108307A

2. Adhere the insulation④ for opening of unit to the opening, (Fig.2)

Put the insulation ④ to be suitable for the hole of the insulation ④ and hole of the indoor unit.
However, put the insulation ④ so as not to conceal the screw hole of the indoor unit.

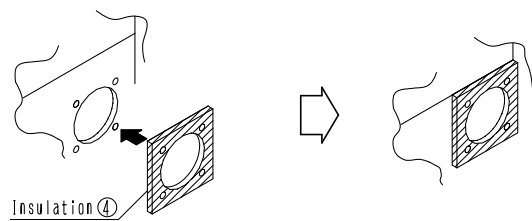

Fig. 2

3. Install the duct flange① with screws② (M4x12, 4 screws) to the opening and adhere the insulation③ (Fig.3)

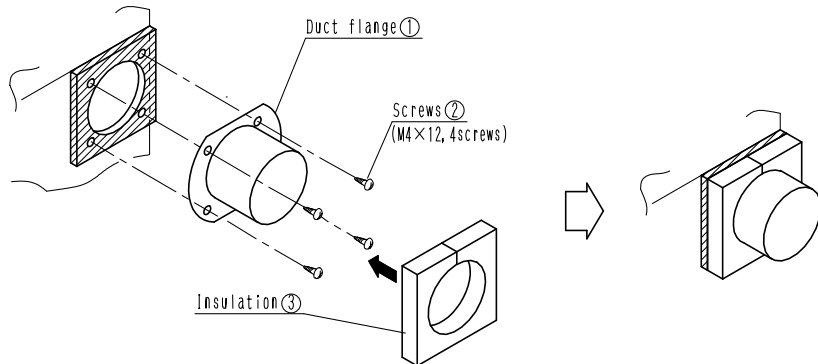

Fig. 3

2 Installation procedures of duct <Nominal diameter of duct: φ100>

1. Connect the duct to the duct flange, (Flange fits inside the duct,)(Fig.4)
2. After connection, wrap vinyl tape (field supply) around the duct connection to prevent air leak.

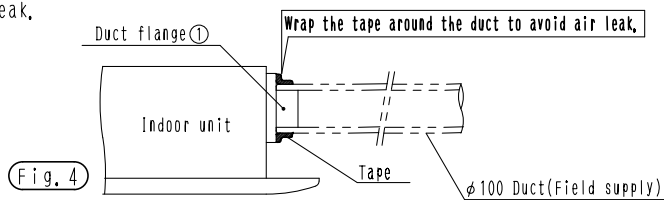

Fig. 4

Precaution

- All ducts must be completely insulated.
- Do not do the followings when installing duct.

- A) To bend the duct excessively B) To bend the duct too many times C) To reduce the duct diameter



WRONG



WRONG

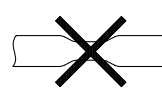

WRONG

2P108307A